

Genuine Accessories



Vehicle Model **MULTIPLE**

Model Year 2019-
 Part No. G9F44 AU000
 Language English
 Rev. Date 12/15/2017

Accessory: **Wheel Locks**

Difficulty: **A**









Note: Difficulty stated above reflects the minimum level of expertise required to install the accessory:
 (A) Customer
 (B) Dealer Technician
 (C) Master Technician or Specialist

Application Notes



Alloy Wheels Only

Wheel Locks must not be applied to steel wheels or the temporary spare tire.

Instructional Symbols / Definitions

 Denotes warnings that may lead to serious physical injury or vehicle damage  Denotes cautions to be taken to avoid physical injury or electronic component damage  Denotes cautions to be taken to avoid vehicle and component damage	 Denotes quality processes to be checked prior to moving to the next step  Denotes specific tools that are necessary to complete a step <div style="border: 1px solid black; padding: 2px; display: inline-block; text-align: center;"> N O T E </div> Denotes important information to be reviewed during the step	Denotes personal protective equipment (PPEs) that may be required for a step. Examples of safety equipment icons noted below: <div style="display: flex; justify-content: space-around;"> <div style="text-align: center;">  Glasses </div> <div style="text-align: center;">  Gloves </div> </div> <div style="display: flex; justify-content: space-around; margin-top: 10px;"> <div style="text-align: center;">  Mask </div> <div style="text-align: center;">  Hearing Protection </div> </div>
---	---	---

Basic Required Tools

	
<p>21mm Deep Socket with Protective Sleeve</p>	<p>Torque Wrench</p>

Part Weight (Gross)

0.65	lbs
0.30	kg

FMVSS 110 Compliance Information

All dealers must determine if the weight they have added in the form of all options or accessories, when added to the weight of all Port/Dealer Installed options or accessories, exceeds the lesser of 1.5% of GVWR or 100 lbs. If the additional weight does exceed the lesser of the indicated thresholds, a "Load Carrying Capacity Reduced" label must be installed. A black, fine-point, indelible marker must be used to write by hand onto the label, the reduced carrying capacity in kilograms or pounds, which is the total weight of all added options and accessories.
Load Label Part Number: NP070 - 09003

Notes to the installer:

- 1 Read the entire Installation Instructions prior to beginning the installation of the part.
- 2 Make sure the vehicle is completely clean and dry in the area(s) the part is to be installed.
- 3 Ensure the vehicle is properly protected in the area(s) that the accessory is to be installed.
- 4 NEVER place tools on painted surfaces, seating surfaces, dash pad, console or floor carpet/mats.
- 5 Always wear appropriate personal protective equipment, including gloves, safety glasses, etc., when required.
- 6 Use of an impact wrench may cause permanent damage to the lock and key. If in doubt about lock application, ask your dealer for assistance.
- 7 For ease of installation and removal, the wheel lock should always be the last lug nut tightened and the first one loosened when removing or installing the wheels.

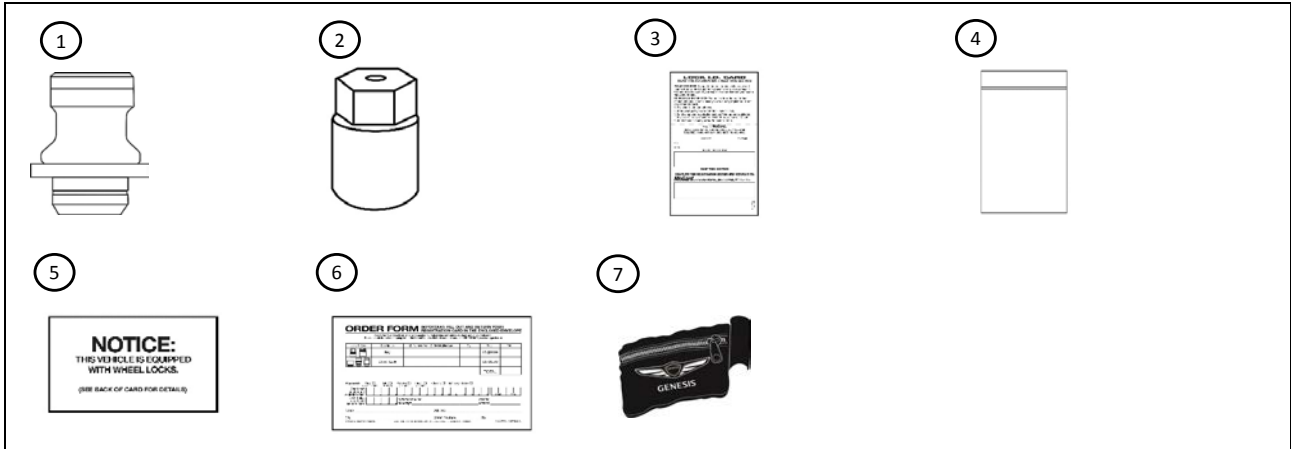

Genuine Accessories

Kit Overview





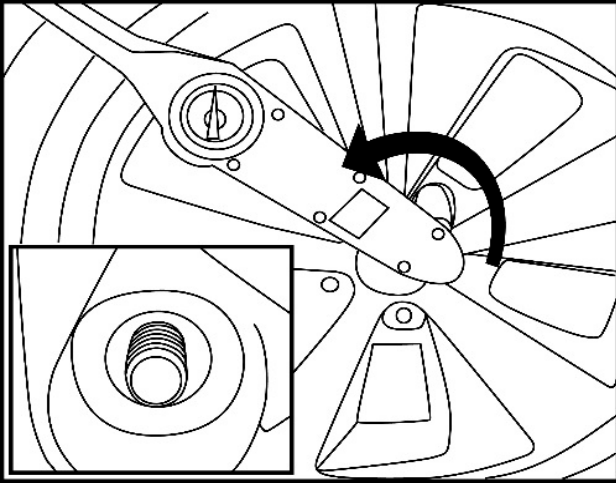

No.	Qty	Description	No.	Qty	Description
1	4	Wheel Lock	6	1	Order Form/Envelope
2	1	Wheel Lock Key	7	1	Key Pouch
3	1	ID/Registration Card			
4	1	Plastic Zip Bag			
5	1	Important Notice Card			

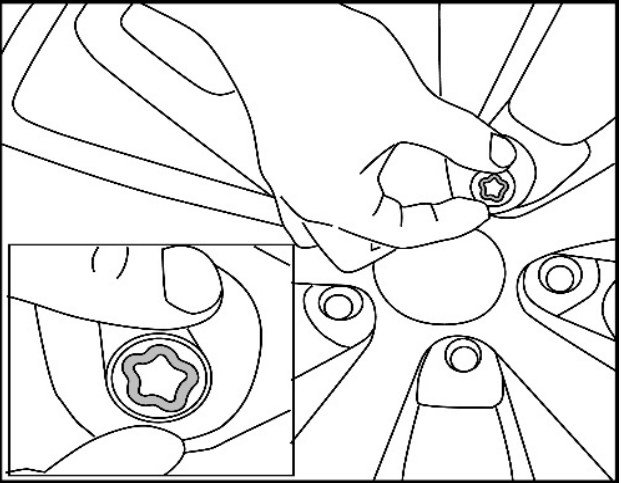
Genuine Accessories

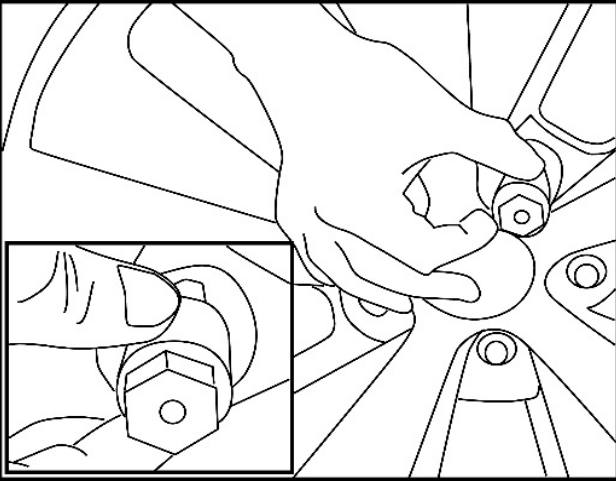
1	 21mm Deep Socket with Protective Sleeve and Torque Wrench
	
N O T E	<p>A. Remove one (1) lug nut from each wheel using a 21mm deep socket with protective sleeve. Do not allow the socket to scrape the wheel while removing the lug nuts.</p> <p>NOTE: A power tool or other suitable tool, may be used to remove the factory lug nut using a 21mm deep socket with protective sleeve.</p>
	<p>CAUTION: Make sure the socket does not scrape the wheel when removing lug nuts.</p>

2	
	
N O T E	<p>A. By hand, install one (1) Wheel Lock onto each wheel.</p>

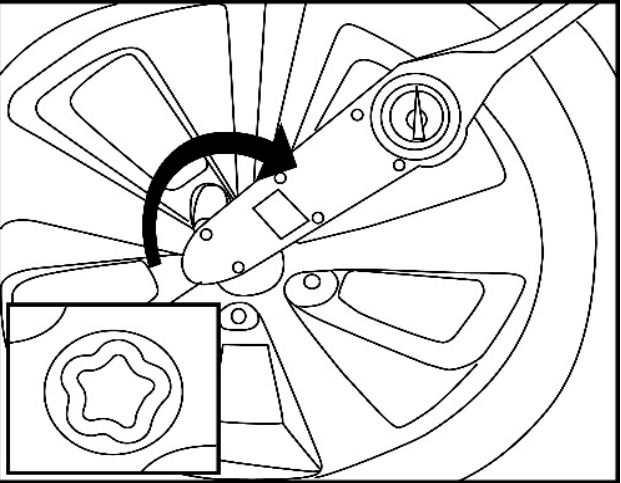
3	
	
N O T E	<p>A. Using the supplied Wheel Lock Key, place it on top of each Wheel Lock, turning until the Wheel Lock Key and Wheel Lock patterns engage.</p> <p>B. Tighten each Wheel Lock by hand. Do not use an impact gun.</p>
	<p>CAUTION: Use of an impact gun may cause permanent damage to the Wheel Lock and Wheel Lock Key.</p>

4	 21mm Deep Socket with Protective Sleeve and Torque Wrench
	
N O T E	<p>A. Using a torque wrench and 21 mm deep socket with protective sleeve, place the socket on the Wheel Lock Key, and while applying inward pressure, tighten to the factory torque specification for each Wheel Lock. Do not allow the socket to scrape the wheel while tightening.</p>
	<p>CAUTION: Use of an impact gun may cause permanent damage to the Wheel Lock and Wheel Lock Key.</p>

Genuine Accessories

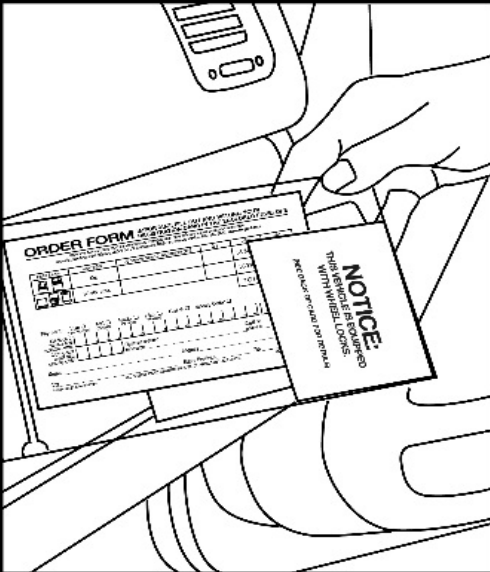
5		
N O T E	<p>A. Place the supplied Important Notice Card, ID/Registration Card and Order Form/Envelope in the Plastic Zip Bag, and place it in the vehicle glove compartment.</p>	

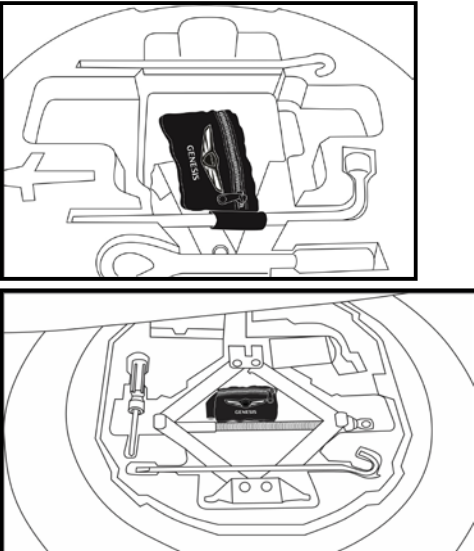
6		
N O T E	<p>1. Store the Wheel Lock Key and the Vehicle Lug Nuts removed in step 1, inside the key pouch. Attach the key pouch to the vehicle lug wrench by sliding the lug wrench through the elastic sleeve. Alternately, store securely in a suitably sized empty compartment in the spare tire kit.</p>	

Visual Check

	Item to be Checked
	Make sure each Wheel Lock is torqued to the factory specification.
	Make sure the Wheel Lock Key and vehicle lug nuts are properly stored in the key pouch.
	Ensure key pouch is securely placed onto vehicle lug wrench to avoid any rattles/noise.

	Result
	Wheel Locks torqued to factory specifications.
	Wheel Lock Key and vehicle lug nuts properly stored.
	Key pouch is securely attached to vehicle lug wrench.